



A Simple Guide to Duck Raising



Partners in Sustainable Community Development



Table of Contents

1 Preface	2
2 Introduction to Duck rearing	3
3 Types of Ducks	4
4 Advantages of Duck Farming	5
5 How many ducks should you raise?	6
6 Choosing a place to raise ducks	7
7 How to choose good ducks	8
8 How to handle your ducks	8
9 How to keep ducks safe and well	10
10 After you get your ducks	11
11 Nests	14
12 Raising Baby Ducks	15
13 Water	17
14 Feeding	18
15 Duck Health	19

Preface

This manual is designed as a resource guide to the participants of the Turtle Village Trust Agricultural Training Programmes. It is intended to give an intermediate approach to guide the reader/farmer in the basics of duck rearing with the intention of establishing a sustainable enterprise.

Turtle Village Trust would like to acknowledge our partners in sustainable community development BHP Billiton, JB Fernandes Memorial Trust and Atlantic LNG without whom this valuable resource would not be possible. Turtle Village Trust would also like to thank the Ministry of Food Production for their support in this project and all others who contributed in making this endeavor possible.

Dr. Allan Bachan

Partners in Sustainable Community Development



2. Introduction to duck raising



Duck raising in Trinidad and Tobago, like raising chickens for meat, can be a full-time specialized business requiring efficiency. The growing commercial market for duck meat is linked with the increasing population. Duck meat generally commands a good price, well above the prices received for chicken. The meat is marketed as fresh, frozen and chilled products, either whole or in parts.

There are problems associated with keeping ducks for egg production on a large scale because of low egg numbers, high feed consumption and the need to house ducks in small numbers. The main egg-laying breeds of ducks can lay more and larger eggs than can hens, but ducks eat about 75% more feed.

For these reasons, most farmers concentrate on meat production. Ducks rearing is being promoted to small community farmers as a means of sustainable livelihood development. There are also a few smaller family farms that have ducks grown for them on contract farms, as well as operators who are involved in all aspects of production, plucking and including direct sales.

Basic Duck Care



Ducks are raised under a wide variety of conditions, ranging from a backyard coop for a few ducks to housing for large flocks on a commercial duck farm. Regardless of the category of duck keeping, there are certain basic requirements that must be met if ducks are to remain healthy. This booklet is intended to educate duck farmer with regard to meeting these basic requirements.

Ducks adapt well to a wide range of systems of care provided they receive essential basic care. Except for the early brooding stage, when ducklings require a higher temperature and special attention by the farmer, the basic requirements of ducks are outlined in this guide

Duck Care Standards

The environment that ducks are kept in must be designed to promote duck well-being and protect ducks from discomfort and distress.

Ducks are known to be strong birds. They are not affected easily by some bird diseases not like turkeys and chickens. However, you still need to practice proper care.

Choosing what breed you want to keep is important. There are duck breeds that are more suited for particular purposes like providing meat or giving eggs. Hope this simple duck farming guide gave a head start in your new venture.

3. Types of Ducks



The Muscovy duck belongs to the genus *Cairina* and originated in South America. It is a good multipurpose breed and has good flavour meat. It is a medium egg producer. The young are hardy and easy to rear. It is a good grazer and thus ideal for back-yard operations. The male Muscovy can become very large (4.5 to 5.5 kg) while the female is smaller (2.3 to

2.8 kg). Market Age 12weeks.

Muscovy differs from other breeds in the following ways:

- It goes broody and will sit on and hatch eggs of other breeds as well as its own.
- It flies, and perches on roosts and trees.
- If already mated with members of its own breed, it will not mate with members of other breeds.
- Where cross-matings are successful, the crossbred progeny are infertile and are known as 'mules'.
- The drake, unlike in other breeds, has no curl feathers in his tail.
- Both male and female Muscovies 'hiss' rather than 'quack'.
- Muscovies are poor egg producers, and lay their eggs in clutches; that is, they may lay 20 or so eggs and go broody or pause before producing again.
- Its eggs take 35 days to hatch, whereas eggs of other breeds take only 28 days.
- Its meat has a lower fat content than that of other ducks.



The Pekin duck is ideal for commercial production due to its good egg producing capabilities and hatchability. It adapts well to confinement and is a good egg producer. The pekin duck has a good meat yield and flavour. Market Age 7weeks.

The Mule is the result of a cross between the Muscovy male and the Pekin female. It is faster growing than the Muscovy and produces a good lean meat yield with succulent flavour. This breed is however sterile. Market Age 8 weeks.



4. Advantages of Duck Farming

Duck farming has following advantages:-

1. Ducks lay more egg per bird per year than chicken.
2. The size of the duck egg is larger than hen egg by about 15 to 20 g.
3. Ducks require lesser attention and thrive

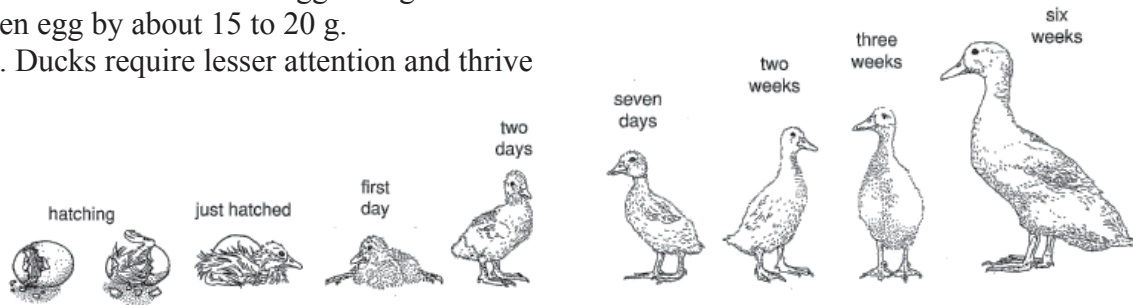

well in scavenging conditions. With very little time and work you can raise a small flock of ducks.

4. Ducks supplements their feed by foraging. They eat grass, insects, snails, earthworms, small fishes and other aquatic materials.
5. From commercial point of view, ducks have a longer profitable life. They lay well even in second year.
6. Ducks do not require any elaborate houses like chicken
7. Ducks are quite hardy, more easily brooded and more resistant to common avian diseases.
8. Marshy river side, wet land and water logged areas upon which chicken or no other type of stock will flourish, are excellent quarters for duck farming.
9. Ducks lay 95 – 98% of their eggs in the morning before 9.00 AM thus saving lot of time and labour.
10. Ducks are suitable for integrated farming systems such as duck-cum-fish farming. In duck-cum-fish farming the droppings of ducks serve as feed for the fishes and no other feed or manuring of the pond is necessary for fishes (200-300 ducks per hectare of waste area). Under integrated duck farming with rice cultivation, the ducks perform four essential functions viz., intertillage as they search for food, their bills loosen up the soil around the rice plants-weeding, insect control and manuring.
11. Ducks are good exterminators of potato beetles, grasshoppers, snails and slugs. In areas plagued liver flukes, ducks can help correct the problem (2 to 6 ducks per 0.405 hectare of land). Ducks can be used to free the bodies of water from mosquito pupae and larvae (6 to 10 ducks per 0.405 hectare of water surface)
12. Ducks are quite intelligent, can be tamed easily, and trained to go to ponds and come back in the evening of their own.

5. How many ducks should you raise?

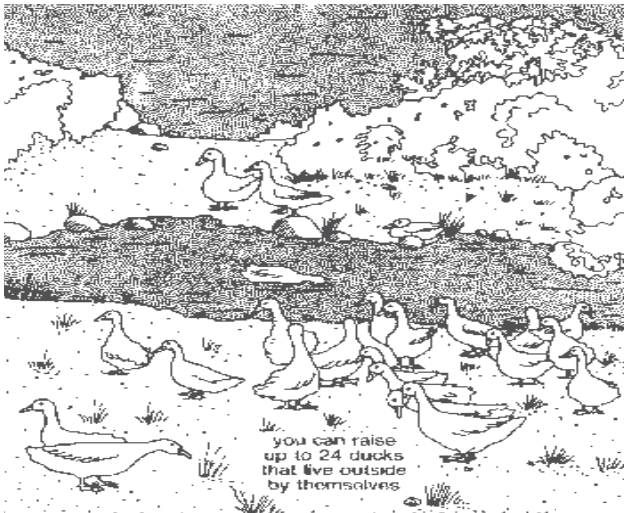

If you are going to raise ducks that live by themselves and find their own food, with very little help from you, you can raise up to 24 ducks.

However, until you know more about ducks and how to take care of them, it is best to start with a small flock. Start with a flock of 6 ducks, 5 female ducks, and 1 male duck.

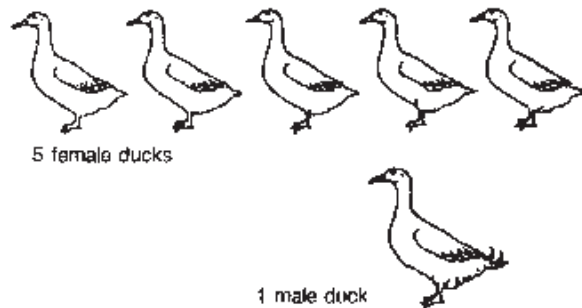

With a flock of 6 ducks you will get 5 to 10 eggs each week.

In addition, with a male in your flock the eggs you get will be fertile. This means that you can raise your own baby ducks.

After you have raised a small flock, you may find that you could use more eggs and more meat. Later you can use some of your eggs to raise baby ducks to make your flock bigger.



If you are starting with ducklings then you should purchase at least 20 ducklings. This is due to the higher mortality of ducklings.

6. Choosing a place to raise ducks

The first thing that you must do is to choose a place on your land that is good to raise ducks.



It is best to keep your ducks where you can watch them easily. So, the place that you choose should be as close as possible to where you live.

Look for a place that has shade for your ducks on hot days. There should also be a place for them to go for protection from wind or on days when it is cold or wet.



If possible look for a place on your land that has enough of the kinds of food that ducks like to eat.

A good place is one near to water where your ducks can easily get to water and where they can swim.

Raising a flock of ducks is only one use for your land, so be careful not to choose a place for them that could be better used for something else, such as planting crops or growing a vegetable garden.

Remember, that ducks can live just about anywhere outside as long as they can find enough to eat and drink.

7. How to choose good ducks

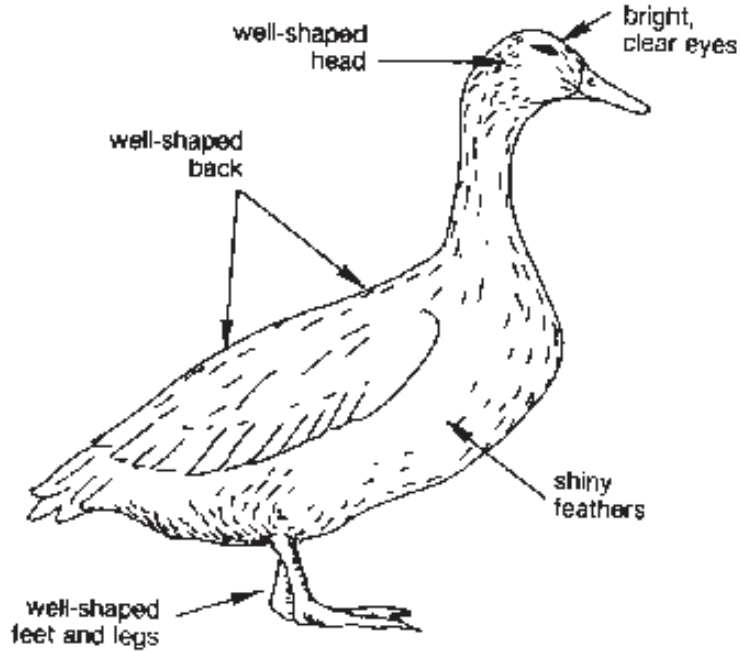

It is best to choose your ducks from a place where you can see them before you buy them. If you watch them carefully you will be able to see the difference between healthy, strong ducks and sick, weak ducks.

If a duck looks well, has well-shaped legs, feet, wings, back and head, and if it moves about well, it is probably a good duck to buy.

8. How to handle your ducks

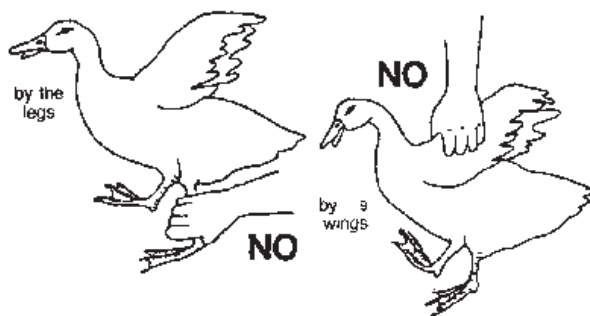

The legs or wings of a duck can easily be hurt or even broken. So, never grab a duck by the legs or the wings.

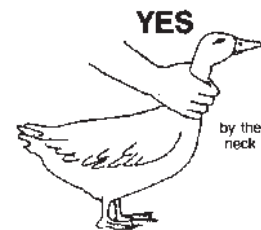

To catch a duck, grasp it firmly but gently at the base of the neck.

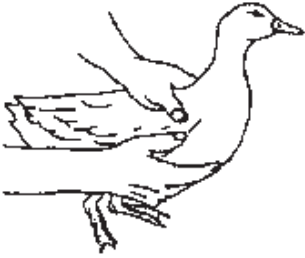

You can also catch a duck by holding its wings against its sides with one hand on each side of its body and a thumb over each wing.

After you have caught a duck, slide one hand under its body and hold its legs firmly. Then you can rest the body of the duck on the lower part of your arm and carry it easily.

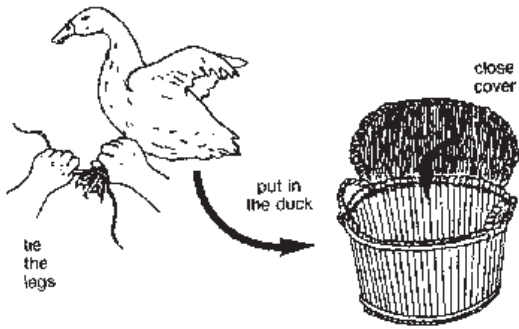
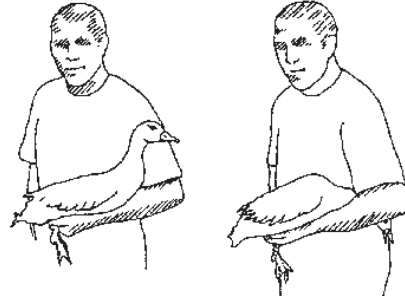

If you have to move a duck from place to place, you can carry it in a box or a crate with a cover.

First, tie the legs of the duck together. Then put it gently inside and put on the cover to keep the duck from getting out.

9. How to keep ducks safe and well



Although ducks can live outside by themselves, they will live much better if they have a shelter.

The main reason for building a shelter for your ducks is to keep them safe from enemies at night when they are sleeping.

Ducks, especially young ducks, have many enemies. You must be careful to protect them from

- dogs, cats, mongoose,
- rats, snakes
- thieves

There are also other reasons for building a shelter. Here are a few.

1. Ducks sleep on the ground. If the ground is cold or wet or dirty, they may get sick.

2. If you build them a shelter, you can keep it dry and clean so your ducks will not get sick.

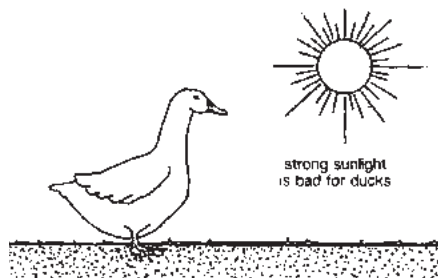

3. Strong sunlight is bad for ducks. They need protection from the sun in very hot weather. Strong sunlight is bad for ducks.

4. If you build a shelter for your ducks, they can go inside when it is very hot.

5. Ducks lay eggs mostly at night or early in the morning.

6. If you build a shelter with nests and keep your ducks inside at night, you will be able to collect the eggs more easily.



10. After you get your ducks

When you bring your ducks home, put them in their shelter, close the door and go away. That way they can settle down, become calm and get used to their new home.

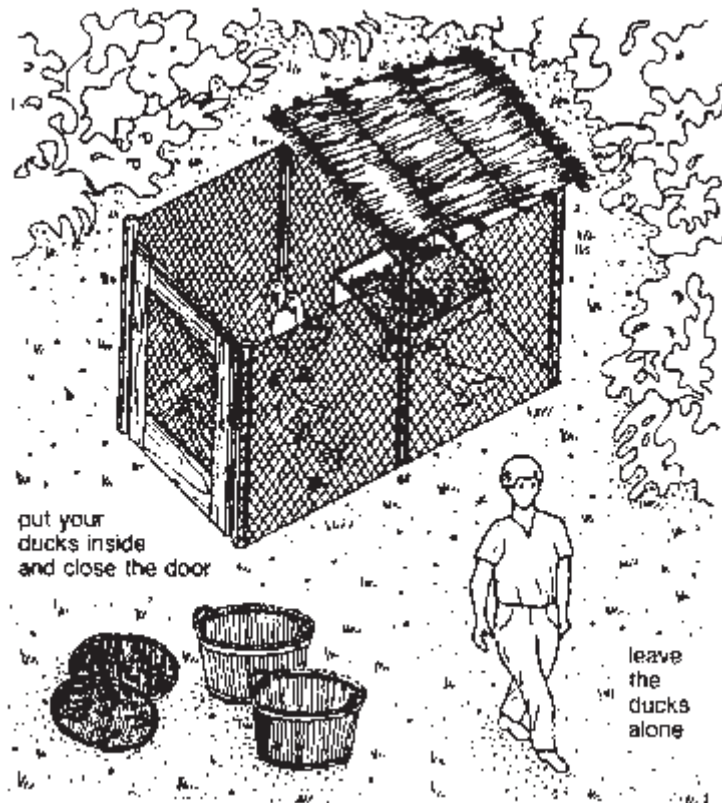

Later the same day, just before the sun goes down, give them some food to eat and some water to drink. However, give them the food and water inside the shelter.

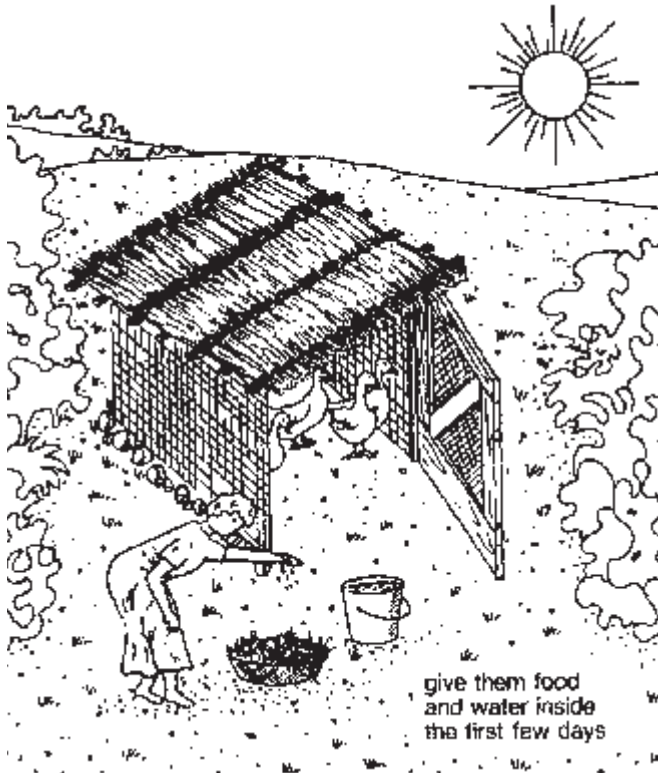

If you see that your ducks eat all the food that you give them, give them a little more.

Keep your ducks in their shelter for the first 2 or 3 days. However, be sure to give them some food and chopped greens each night just before dark and make sure that they have water.

When you see that your ducks are calm and used to their new home, you can let them out for the day.

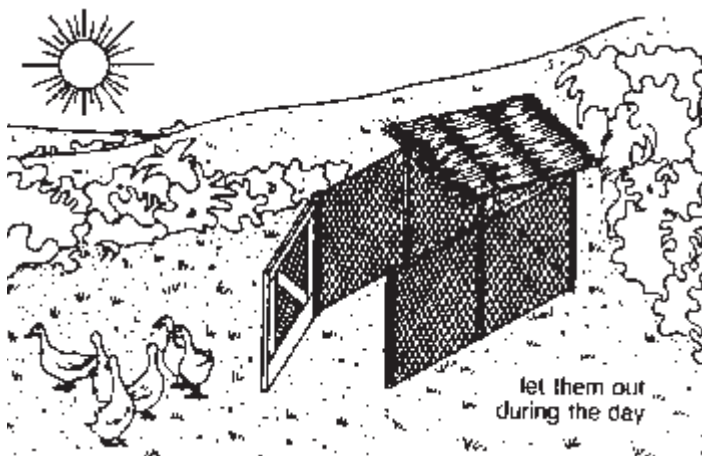

Let your ducks out a few hours after the sun is up. That way they will lay their eggs inside so that you can collect them easily.

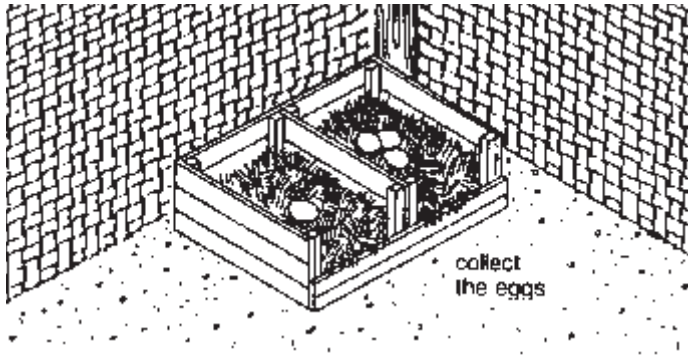

During the day your ducks will wander about looking for insects and worms and grass and roots and other things that they like to eat. Then, each night just before dark give them food.

However, this time give them food in front of the shelter, not inside. That way it will stay clean inside.

By giving your ducks food in front of their shelter each night, they will become used to coming back to eat at that time.

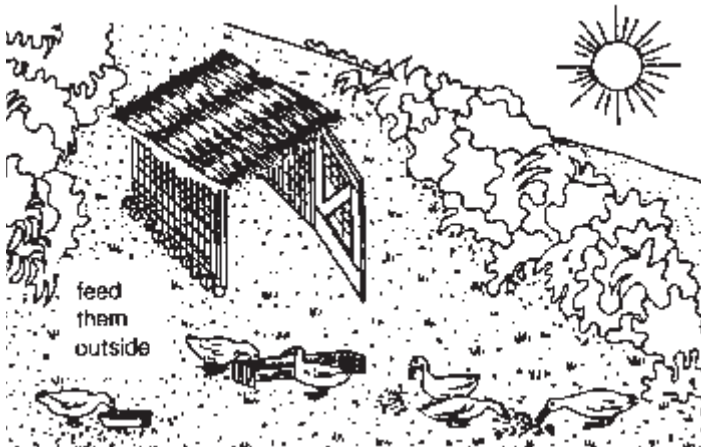

When your ducks have eaten, you can close them safely inside until the next morning.

During the first few weeks, check on your ducks from time to time during the day to see where they are.

However, soon they will learn to go out in the morning and come back by themselves at night. You will have to do very little for your ducks.

11. Nests



Encourage ducks to use nests because cleaner eggs result and fewer breakages occur. Furthermore, eggs laid in nests are not exposed to sun or damp. This may be difficult with breeds other than Muscovies.

Building nests

You have already learned that ducks mostly lay their eggs either at night or very early in the morning.

If you keep your ducks inside at night and give them nests to use, there will be fewer broken eggs and you can collect them more easily. As soon as you have finished building a pen or a house you are ready to build the nests.

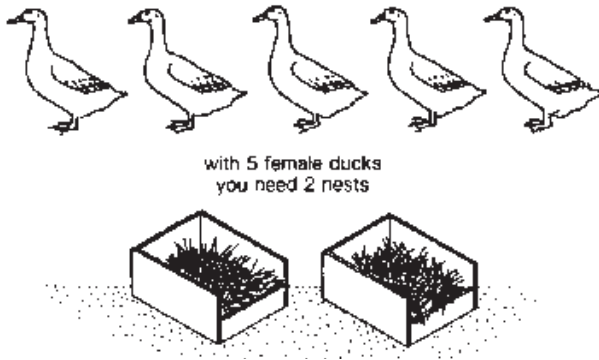

You will need 1 nest for every 3 female ducks. So, when you first begin with a flock of 6 ducks (5 females and 1 male ducks) you will need 2 nests.

With 5 female ducks you need 2 nests

Nests should be clean, dry, comfortable and only large enough to be used by one duck at a time. Build them from timber and place them in rows along the walls. Ducks like small nests with just enough room to get in, turn around and sit down. So, give your female ducks a cosy nest of just the right size. A good duck nest is about 30 centimeters wide, 38 centimeters deep and, if it has a roof, from 20 to 35 centimeters high. Nesting material should be placed in the nest to a depth of about 7cm. Use shavings, sawdust, or sand. Broody ducks will further line their nests with their own body feathers. Be sure to change the grass in each nest as soon as it gets dirty.

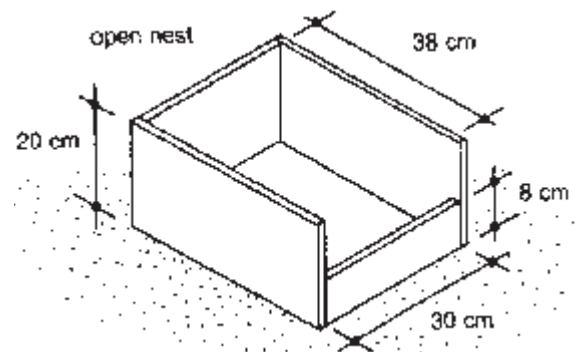

note: nests rest on the ground and do not need a bottom

12. Raising Baby Ducks: Brooding Baby Ducks

Start your ducklings off in a safe and warm environment: a **duck brooder**! For the best environment use a heat lamp with between a 40 and 100 watt light bulb. You can adjust the bulb wattage according to the way the ducklings react. If the baby ducks are huddling under the heatlamp, you probably should raise the wattage on the bulb. If the baby ducks are scattered and seem to be panting, you should lower the wattage. **Be sure that they can get away from the heat source if they get too warm.**



The ideal brooder when raising baby ducks for the first few weeks is a plastic crate or box. Once the ducklings you're raising are larger and beginning to outgrow the box, you can build an outdoors coop like you would have for chicken coops. Just make sure the duck coop is predator resistant. Remember, rats, cats and mongoose will eat your ducklings until they are bigger and can fly away from them.

When raising baby ducks, make sure you provide the ducklings with fresh, clean drinking water. You can use a shallow dish that you have added some clean pebbles to. The pebbles will prevent the ducklings from submerging their head and drowning. They need to submerge their head in order to clear their sinuses but any deeper than the nostrils can drown them. Ducklings can die if they are without water for even short periods.

Ducklings make quite a mess when eating, and their droppings are prolific and wet. Feeders must be constructed and maintained so ducks have easy access to feed at all times. Feeders must be kept clean and free from litter/manure. Moldy feeds must not be fed. Stale or contaminated feed must not be allowed to accumulate and must be replaced immediately with fresh feed.



Place feeders on an elevated platform to prevent them from becoming contaminated with droppings. Both feeders and drinkers must be easily accessible. For each duckling up to 3 weeks of age, provide 1.5 cm of drinking space and 4 cm of feeding space. Your duckling should be fully feathered before allowing them to swim.

Give five equally spaced feedings throughout the day and make sure they do not have more than they can eat at one feeding.

You may not believe this but...



Ducklings are **fully grown** in 30 days

13. Water



Though duck is a water fowl and very fond of water, WATER FOR SWIMMING IS NOT ESSENTIAL AT ANY STAGE OF DUCK REARING. However, water in drinkers should be sufficiently deep to allow the immersion of their heads and not themselves. If they cannot do this, their eyes seem to get scaly and crusty and in extreme cases, blindness may follow. In addition, they also like to clean their bills periodically and wash them to clear off the feed. Keep drinking containers

shaded at all times.

Swimming facilities are not essential. However, pools can be made available where outside runs are provided. Concrete ponds 1 m wide by 0.25m deep are satisfactory. To keep litter in the shed dry, place the ponds away from the house. Alternatively, saucer-shaped pools 0.25m deep and 2 m wide may be used. In both cases, good drainage is essential. To limit wastage of eggs, it is advisable to prevent outside swimming until about 10.00 am, when most eggs will have been laid (most ducks lay their eggs in the evening and early morning).

14. Feeding



Ducks may be grown on pellets. The pellet feeding, though slightly costly, has distinct advantages such as saving in amount of feed, minimum wastages, saving in labor, convenience and improvement in sanitary conditions. **"Starter and Grower" available at your local feed store, until they are feathered out and "Layer and Finisher" for adults. Never feed them medicated poultry feeds.** Ducks are good foragers. The use of the yard, drain or supplementary green feed (grass), reduces the feed cost.

DUCKS SHOULD NEVER HAVE ACCESS TO FEED WITHOUT WATER. During the first eight weeks, birds should always have access to feed, but later on they may be fed twice a day i.e. first in the morning and then late afternoon. Ducks consumes on average about 12.5 gs. of feed up to 20 weeks of age. Afterwards the consumption varies from 120 gms and above per bird per day and depending upon the rate of production and availability of greens.

Feed consumption

Table 1 serves only as a guide to expected feed consumption. The actual amount of feed eaten will depend upon factors such as quality of feed, strain of ducks and method of management.

Table 1. Average feed consumption of Muscovies ducks (mixed sexes)

Age (weeks)	Feed for week (kg)	Cumulative feed (kg)
0-1	0.15	0.15
1	0.40	0.55
2	0.75	1.30
3	0.95	2.25
4	1.00	3.25
5	1.30	4.55
6	1.65	6.20
7	1.80	8.00
8	1.60	9.60

Feed conversion ratios

The feed conversion ratios for Muscovies ducks are around 2.5:1 when ducklings are marketed at 6 weeks of age with a liveweight of nearly 3 kg.

15. Duck Health

The normal behaviour of a duck is to be alert with a level carriage. They often waddle around and peck as they investigate the surroundings. Ducks will emit characteristic quacking or honking noises when their territories are entered.

Ducks are resistant to common avian diseases and internal parasites. The infestation of internal parasites is prevalent only among those ducks which have access to stagnant water and over-crowded pond. The parasites include flukes, tape worms and round worms.

The external parasites are an infliction rather than an ailment. These include lice mites, fleas and ticks. These cause irritation and annoyance leading to loss in egg production.

Ducks should appear healthy and show normal behaviors. Signs of good duck health depend on age, sex, and breed. Important indications of good health are as follows:

- Good posture
- Vigorous movements if disturbed
- Clean and healthy skin
- Good plumage
- Well-formed shanks and feet
- Effective walking
- Preening
- Active feeding and drinking
- Clear, bright eyes

The early symptoms of stress or ill health can be the following:

- Head pulled into the body
- Huddling, appearing chilled
- Changes in feed and water intake
- Lack of preening, general inactivity
- Diarrhea
- Problems with coordination (walking/sitting)
- Drooping of the eyelids, reduced or squinted eyes
- Puffy head and lower live weight

HEALTH COVER

A. Means of disease spread through:	B. General Principles for Prevention of Diseases.	C. What to be done at the time of an out break
<ol style="list-style-type: none"> 1. Wet litter. 2. Feed and water. 3. Close contact. 4. Contaminated equipment. 5. Attendants and visitors. 6. Air. 7. External parasites. 8. Free moving birds. 9. Rodents and flies. 	<ol style="list-style-type: none"> 1. Procure day old ducklings from disease free flock. 2. Maintain proper hygienic conditions. 3. Provide adequate feed, water and floor space etc. 4. Rodents and wild birds etc should be prevented to enter the houses. 5. Follow regular vaccination schedule. 6. Proper disposal of dead birds. 7. Footbaths should be provided at the entrance of each shed. 8. Reduce stress effect. 9. Ensure clean and adequate water supply. 10. Use of suitable litter material and periodical turning is essential to keep it dry. 	<ol style="list-style-type: none"> 1. Restrict the movement of ducks (selling and buying) 2. Follow strict hygienic measures. 3. Take help of Veterinarians.